

TURBÓMARÓK

Turbómaró, cylinder alakú, FA forma

d_1 Fej Ø	l_2 Fejhossz.	l_1 Hossz.	d_2 Csap Ø	Nr. 1	Nr. 2
1,5	6	50	3	FA – 3002	FA – 3033
1,5	6	75	3	FA – 3003	FA – 3034
2,5	11	50	3	FA – 3005	FA – 3036
2,5	11	75	3	FA – 3006	FA – 3037
3	14	50	3	FA – 3008	FA – 3039
3	14	75	3	FA – 3009	FA – 3040

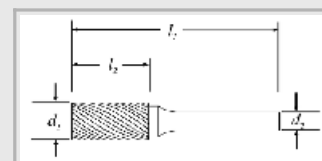

d_1 Fej Ø	l_2 Fejhossz.	l_1 Hossz.	d_2 Csap Ø	Nr. 1	Nr. 2
6	12,7	162	6	FA – 3018	FA – 3049
9,5	19	169	6	FA – 3023	FA – 3054
12,7	25	175	6	FA – 3028	FA – 3059

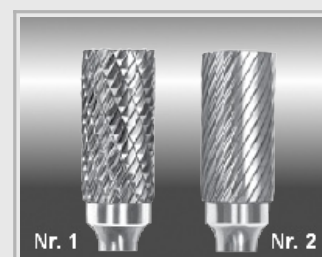

Non-ferro / Aluminium

d_1 Fej Ø	l_2 Fejhossz.	l_1 Hossz.	d_2 Csap Ø	Nr. 3.
6	16	50	6	FA – 3063
9,5	19	63	6	FA – 3064
12,7	25	69	6	FA – 3065
16	25	69	6	FA – 3066
19	25	69	6	FA – 3068

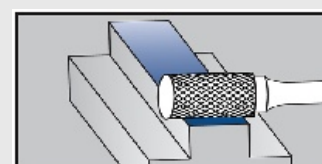

TURBÓMARÓK

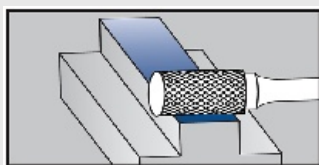
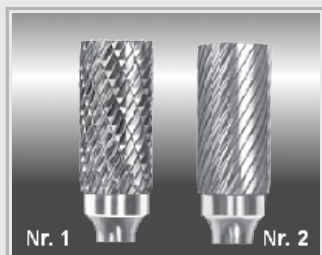
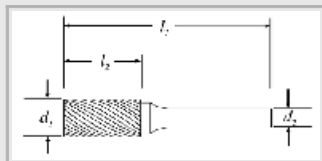

Turbómaró, cylinder alakú, FA forma

d_1 Fej Ø	l_2 Fejhossz.	l_1 Hossz.	d_2 Csap Ø	Nr. 1	Nr. 2
1,5	6	38	3	FA – 3001	FA – 3032
2,5	11	38	3	FA – 3004	FA – 3035
3	14	38	3	FA – 3007	FA – 3038
4	12,7	38	3	FA – 3012	FA – 3043
5	12,7	38	3	FA – 3014	FA – 3045
6,3	12,7	50	3	FA – 3019	FA – 3050

d_1 Fej Ø	l_2 Fejhossz.	l_1 Hossz.	d_2 Csap Ø	Nr. 1	Nr. 2
3	12	56	6	FA – 3010	FA – 3041
3	12,7	60	6	FA – 3011	FA – 3042
4	16	50	6	FA – 3013	FA – 3044
5	16	50	6	FA – 3015	FA – 3046
6	16	50	6	FA – 3016	FA – 3047
6	25	50	6	FA – 3017	FA – 3048
8	19	63	6	FA – 3020	FA – 3051
9,5	19	63	6	FA – 3021	FA – 3052
9,5	25	69	6	FA – 3022	FA – 3053
10	20	60	6	FA – 3024	FA – 3055
11	25	69	6	FA – 3025	FA – 3056
12	25	65	6	FA – 3026	FA – 3057
12,7	25	69	6	FA – 3027	FA – 3058
16	25	69	6	FA – 3029	FA – 3060
19	25	69	6	FA – 3030	FA – 3061
25	25	69	6	FA – 3031	FA – 3062

TURBÓMARÓK

Turbómaró, cylinder alakú, homlokfogazattal, FB forma

d_1 Fej Ø	l_2 Fejhossz.	l_1 Hossz.	d_2 Csap Ø	Nr. 1	Nr. 2
1,5	6	50	3	FB – 3070	FB – 3096
1,5	6	75	3	FB – 3071	FB – 3097
2,5	11	50	3	FB – 3073	FB – 3099
2,5	11	75	3	FB – 3074	FB – 3100
3	14	50	3	FB – 3076	FB – 3103
3	14	75	3	FB – 3077	FB – 3104

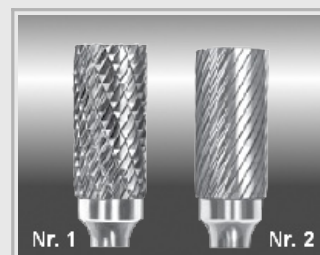
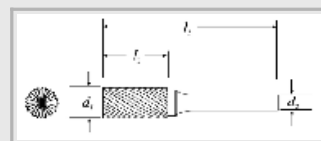

Non-ferro / Aluminium

d_1 Fej Ø	l_2 Fejhossz.	l_1 Hossz.	d_2 Csap Ø	Nr. 3.
6	19	50	6	FB – 3122
9,5	19	63	6	FB – 3123
12,7	25	69	6	FB – 3124
19	25	69	6	FB – 3125
19	25	69	6	FB – 3126

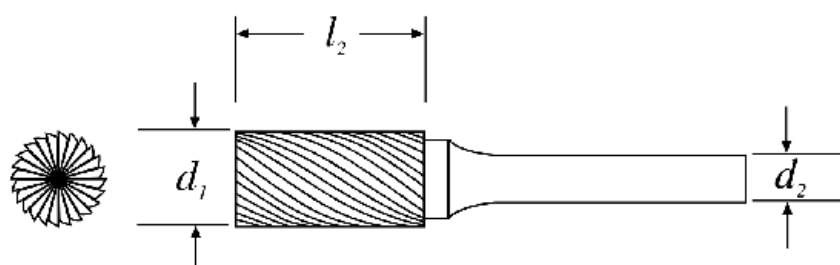
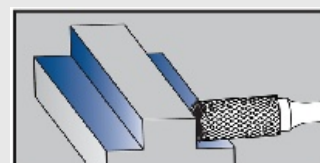

TURBÓMARÓK

Turbómaró, cylinder alakú, homlokfogazattal, FB forma

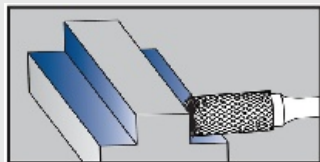
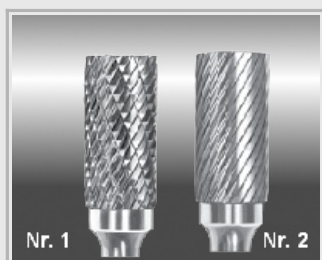
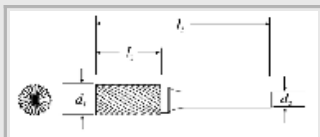

d_1 Fej Ø	l_2 Fejhossz.	l_1 Hossz.	d_2 Csap Ø	Nr. 1	Nr. 2
1,5	6	38	3	FB – 3069	FB – 3095
2,5	11	38	3	FB – 3072	FB – 3098
3	11	38	3		FB – 3101
3	14	38	3	FB – 3075	FB – 3102
6,3	4,7	43	3	FB – 3084	FB – 3111

d_1 Fej Ø	l_2 Fejhossz.	l_1 Hossz.	d_2 Csap Ø	Nr. 1	Nr. 2
3	12	56	6	FB – 3078	FB – 3105
3	12,7	60	6	FB – 3079	FB – 3106
4	16	50	6	FB – 3080	FB – 3107
5	16	50	3	FB – 3081	FB – 3108
6	16	50	6	FB – 3082	FB – 3109
6	25	50	6	FB – 3083	FB – 3110
8	19	63	6	FB – 3085	FB – 3112
9,5	19	63	6	FB – 3086	FB – 3113
9,5	25	69	6	FB – 3087	FB – 3114
10	20	60	6	FB – 3088	FB – 3115
11	25	69	6	FB – 3089	FB – 3116
12	25	65	6	FB – 3090	FB – 3117
12,7	25	69	6	FB – 3091	FB – 3118
16	25	69	6	FB – 3092	FB – 3119
19	25	69	6	FB – 3093	FB – 3120
16	25	69	8	FB – 3094	FB – 3121

TURBÓMARÓK

Turbómaró, gömb, FD forma

d_1 Fej Ø	l_2 Fejhossz.	l_1 Hossz.	d_3 Csap Ø	Nr. 1	Nr. 2
2,5	2,3	38	3	FD – 3185	FD – 3207
3	2,5	38	3	FD – 3186	FD – 3208
4	3,4	38	3	FD – 3190	FD – 3212
5	4,7	38	3	FD – 3191	FD – 3213
6,3	5	44	3	FD – 3195	FD – 3217
3	2,5	50	6	FD – 3189	FD – 3211
5	4	50	6	FD – 3192	FD – 3214
6	5	50	6	FD – 3193	FD – 3215
8	6,4	50	6	FD – 3196	FD – 3218
9,5	8	52	3	FD – 3197	FD – 3219
10	9	49	6	FD – 3199	FD – 3221
11	9,5	54	3	FD – 3200	FD – 3222
12	10,8	51	6	FD – 3201	FD – 3223
12,7	11	55	6	FD – 3202	FD – 3224
16	14	58	6	FD – 3204	FD – 3226
19	16	62	6	FD – 3205	FD – 3227
25	21	72	6	FD – 3206	FD – 3228
3	2,5	50	3	FD – 3187	FD – 3209
3	2,5	75	3	FD – 3188	FD – 3210
6	5	155	6	FD – 3194	FD – 3216
9,5	8	158	6	FD – 3198	FD – 3220
12,7	11	161	6	FD – 3203	FD – 3225

Non-ferro / Aluminium

d_1 Fej Ø	l_2 Fejhossz.	l_1 Hossz.	d_3 Csap Ø	Nr. 3.
6	5	50	6	FD – 3229
9,5	8	52	3	FD – 3230
12,7	11	55	6	FD – 3231
16	14	58	6	FD – 3232
19	16	62	6	FD – 3233

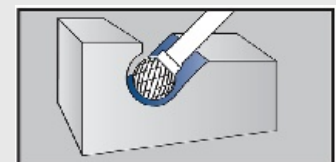
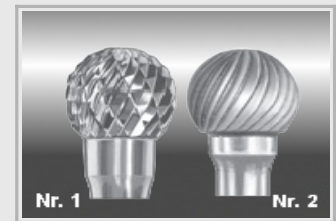
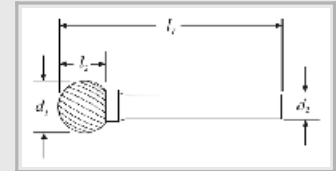

TURBÓMARÓK

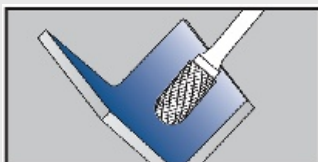
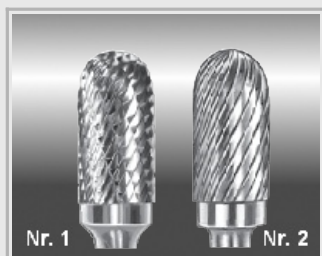
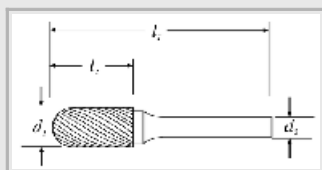

Turbómaró, kerekített cylinder alakú, FC forma

d_1 Fej Ø	l_2 Fejhossz.	l_1 Hossz.	d_2 Csap Ø	Nr. 1	Nr. 2
2,5	11	38	3	FC - 3128	FC - 3154
3	14	38	3	FC - 3129	FC - 3155
4	12,7	38	3	FC - 3134	FC - 3160
5	12,7	38	3	FC - 3136	FC - 3162
6,3	12,7	50	3	FC - 3141	FC - 3167
3	12	56	6	FC - 3132	FC - 3158
3	16	60	6	FC - 3133	FC - 3159
4	16	50	6	FC - 3135	FC - 3161
5	16	50	6	FC - 3137	FC - 3163
6	16	50	6	FC - 3138	FC - 3164
6	25	50	6	FC - 3139	FC - 3165
8	19	63	6	FC - 3142	FC - 3168
9,5	19	63	6	FC - 3143	FC - 3169
9,5	25	69	6	FC - 3144	FC - 3170
10	20	60	6	FC - 3146	FC - 3172
11	25	69	6	FC - 3147	FC - 3173
12	25	65	6	FC - 3148	FC - 3174
12,7	25	69	6	FC - 3149	FC - 3175
16	25	69	6	FC - 3151	FC - 3177
19	25	69	6	FC - 3152	FC - 3178
25	25	69	6	FC - 3153	FC - 3179
3	14	50	3	FC - 3130	FC - 3156
3	14	75	3	FC - 3131	FC - 3157
6	12,7	162	3	FC - 3140	FC - 3166
9,5	19	169	6	FC - 3145	FC - 3171
12,7	25	175	6	FC - 3150	FC - 3176
Non-ferro / Aluminium					
d_1 Fej Ø	l_2 Fejhossz.	l_1 Hossz.	d_2 Csap Ø	Nr. 3.	
6	19	50	6	FC - 3180	
9,5	19	63	3	FC - 3181	
12,7	25	69	6	FC - 3182	
19	25	69	6	FC - 3183	

TURBÓMARÓK

Turbómaró, kerekített nyílhegy alakú, FF forma

d_1 Fej Ø	l_2 Fejhossz.	l_1 Hossz.	d_2 Csap Ø	Nr. 1	Nr. 2
3	6	38	3	FF – 3266	FF – 3286
3	12,7	38	3	FF – 3267	FF – 3287
5	12,7	38	3	FF – 3271	FF – 3291
6,3	12,7	50	3	FF – 3274	FF – 3294
3	12,7	56	6	FF – 3268	FF – 3288
6	16	50	6	FF – 3272	FF – 3292
9,5	19	63	6	FF – 3275	FF – 3295
11	25	69	6	FF – 3277	FF – 3297
12	25	65	6	FF – 3278	FF – 3298
12,7	19	63	6	FF – 3279	FF – 3299
12,7	25	69	6	FF – 3280	FF – 3300
16	25	69	6	FF – 3282	FF – 3302
19	25	69	6	FF – 3283	FF – 3303
19	32	76	6	FF – 3284	FF – 3304
19	38	82	6	FF – 3285	FF – 3305
3	12,7	50	3	FF – 3269	FF – 3289
3	12,7	75	3	FF – 3270	FF – 3290
6	12,7	163	6	FF – 3273	FF – 3293
9,5	19	169	6	FF – 3276	FF – 3296
12,7	25	175	6	FF – 3281	FF – 3301

Non-ferro / Aluminium

d_1 Fej Ø	l_2 Fejhossz.	l_1 Hossz.	d_2 Csap Ø	Nr. 3.
6	19	50	6	FF – 3306
9,5	19	63	6	FF – 3307
12,7	25	69	6	FF – 3308
16	25	69	6	FF – 3309
19	32	76	6	FF – 3310

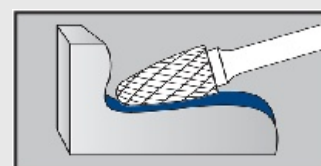
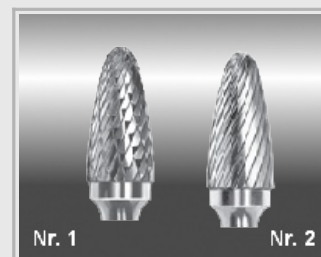
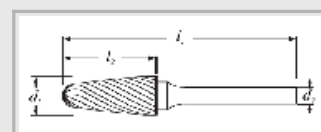

TURBÓMARÓK

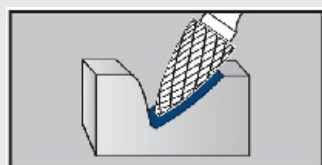
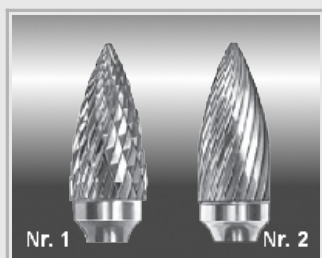
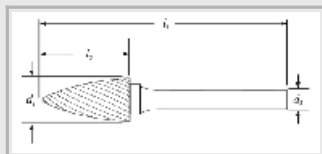

Turbómaró, nyílhegy alakú, FG forma

d_1 Fej Ø	l_2 Fejhossz.	l_1 Hossz.	d_2 Csap Ø	Nr. 1	Nr. 2
3	6	38	3	FG – 3312	FG – 3332
3	9,5	38	3	FG – 3313	FG – 3333
3	12,7	38	3	FG – 3314	FG – 3334
5	12,7	38	3	FG – 3317	FG – 3337
6,3	12,7	50	3	FG – 3320	FG – 3340

6	16	50	6	FG – 3318	FG – 3338
8	19	63	6	FG – 3321	FG – 3341
9,5	19	63	6	FG – 3322	FG – 3342
10	20	60	6	FG – 3324	FG – 3344
12	25	65	6	FG – 3325	FG – 3345
12,7	19	63	6	FG – 3326	FG – 3346
12,7	25	69	6	FG – 3327	FG – 3347
16	25	69	6	FG – 3329	FG – 3349
19	25	69	6	FG – 3330	FG – 3350
19	38	82	6	FG – 3331	FG – 3351

3	12,7	50	3	FG – 3315	FG – 3335
3	12,7	75	3	FG – 3316	FG – 3336

6	12,7	163	6	FG – 3319	FG – 3339
9,5	19	169	6	FG – 3323	FG – 3343
12,7	25	175	6	FG – 3328	FG – 3348

TURBÓMARÓK

Turbómaró, kónuszos, kerekített véggel, FL forma

d_1 Fej Ø	l_1 Fejhossz.	l_2 Hossz.	d_2 Csap Ø	Szög	Nr. 1	Nr. 2
3	9,5	38	3	8°	FL – 3400	FL – 3414
3	12,7	38	3	8°	FL – 3401	FL – 3415
5	12,7	38	3	14°	FL – 3404	FL – 3418

6	16	50	6	14°	FL – 3405	FL – 3419
8	22	69	6	14°	FL – 3407	FL – 3421
9,5	27	74	3	14°	FL – 3408	FL – 3422
12,7	28	76	6	14°	FL – 3410	FL – 3424
16	30	77	6	14°	FL – 3412	FL – 3426
19	38	85	6	14°	FL – 3413	FL – 3427

3	12,7	50	3	8°	FL – 3402	FL – 3416
3	12,7	75	3	8°	FL – 3403	FL – 3417

6	16	166	6	14°	FL – 3406	FL – 3420
9,5	27	177	6	14°	FL – 3409	FL – 3423
12,7	28	178	6	14°	FL – 3411	FL – 3425

Non-ferro / Aluminium

d_1 Fej Ø	l_1 Fejhossz.	l_2 Hossz.	d_2 Csap Ø	Szög	Nr. 3
9,5	27	74	3	14°	FL – 3428
12,7	28	76	6	14°	FL – 3429
16	30	77	6	14°	FL – 3430
19	38	85	6	14°	FL – 3431

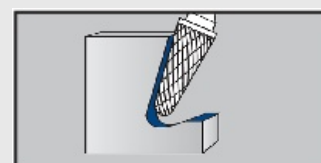
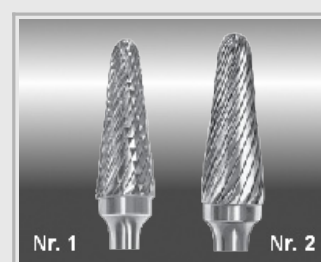
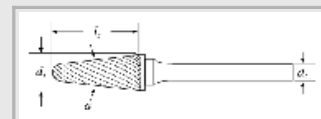

TURBÓMARÓK

Turbómaró, csepp alakú, FE forma

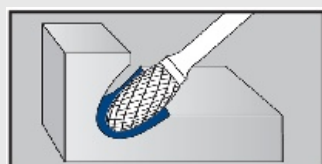
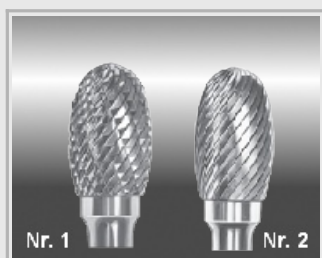
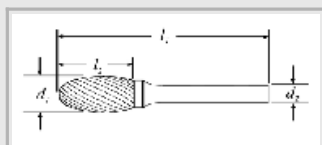

d_1 Fej Ø	l_2 Fejhossz.	l_1 Hossz.	d_2 Csap Ø	Nr. 1	Nr. 2
3	5,5	38	3	FE – 3235	FE – 3248
5	7,1	38	2	FE – 3238	FE – 3251
6,3	9,5	47	3	FE – 3241	FE – 3254

6	9,5	50	6	FE – 3239	FE – 3252
9,5	16	60	6	FE – 3242	FE – 3255
12,7	22	66	6	FE – 3244	FE – 3257
16	25	69	6	FE – 3246	FE – 3259
19	25	69	6	FE – 3247	FE – 3260

3	5,5	50	3	FE – 3236	FE – 3249
3	5,5	75	3	FE – 3237	FE – 3250

Non-ferro / Aluminium

d_1 Fej Ø	l_2 Fejhossz.	l_1 Hossz.	d_2 Csap Ø	Nr. 3.
9,5	16	60	6	FE – 3261
12,7	22	66	6	FE – 3262
16	25	69	6	FE – 3263
19	25	69	6	FE – 3264

TURBÓMARÓK

Turbómaró, láng alakú, FH forma

d_1 Fej Ø	l_2 Fejhossz.	l_1 Hossz.	d_2 Csap Ø	Nr. 1	Nr. 2
3	6,3	38	3	FH - 3352	FH - 3362
5	9,5	38	3	FH - 3355	FH - 3365

8	19	63	6	FH - 3356	FH - 3366
12,7	32	76	6	FH - 3358	FH - 3368
16	36	80	6	FH - 3360	FH - 3370
19	41	85	6	FH - 3361	FH - 3371

3	6,3	50	3	FH - 3353	FH - 3363
3	6,3	75	3	FH - 3354	FH - 3364

8	19	169	6	FH - 3357	FH - 3367
12,7	32	182	6	FH - 3359	FH - 3369

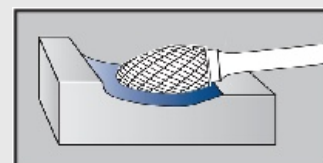
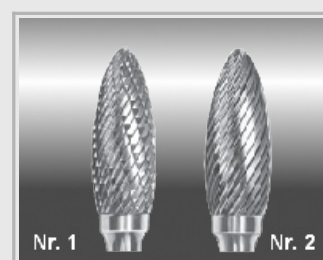
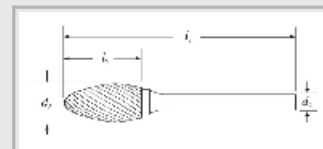

TURBÓMARÓK

Turbómaró, kónuszos, hegyes véggel, FM forma

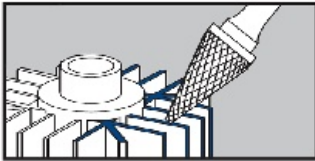
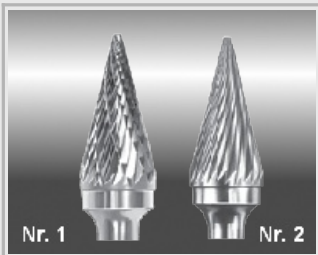
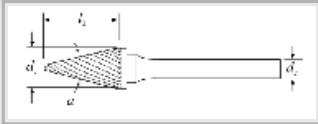

d_1 Fej Ø	l_2 Fejhossz.	l_1 Hossz.	d_2 Csap Ø	Szög	Nr. 1	Nr. 2
3	8,9	38	3	12°	FM – 3433	FM – 3446
3	11	38	3	14°	FM – 3434	FM – 3447
3	16	38	3	7°	FM – 3437	FM – 3450
5	12,7	38	3	16°	FM – 3438	FM – 3451
6,3	12,7	54	3	22°	FM – 3442	FM – 3455

6	12,7	50	6	22°	FM – 3439	FM – 3452
6	19	50	6	14°	FM – 3440	FM – 3453
6	25	50	6	10°	FM – 3441	FM – 3454
9,5	16	63	6	28°	FM – 3443	FM – 3456
12,7	22	69	6	28°	FM – 3444	FM – 3457
16	25	73	6	31°	FM – 3445	FM – 3458

3	11	50	3	14°	FM – 3435	FM – 3448
3	11	75	3	14°	FM – 3436	FM – 3449

TURBÓMARÓK

Turbómaró, külső kónuszos, FN forma

d_1 Fej Ø	l_2 Fejhossz.	l_1 Hossz.	d_2 Csap Ø	Szög	Nr. 1	Nr. 2
2,5	3	38	3	10°	FN – 3459	FN – 3468
3	4	38	3	10°	FN – 3460	FN – 3469
5	6,3	38	3	10°	FN – 3461	FN – 3470
6,3	6	44	3	10°	FN – 3463	FN – 3472

6	8	50	6	10°	FN – 3462	FN – 3471
9,5	9,5	53	6	13°	FN – 3464	FN – 3473
12,7	12,7	57	6	28°	FN – 3465	FN – 3474
16	19	63	6	18°	FN – 3466	FN – 3475
19	16	60	6	30°	FN – 3467	FN – 3476

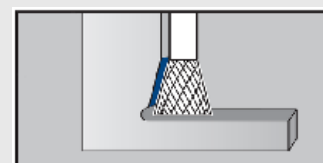
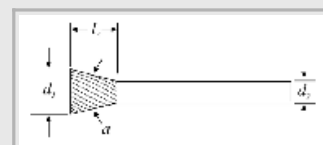
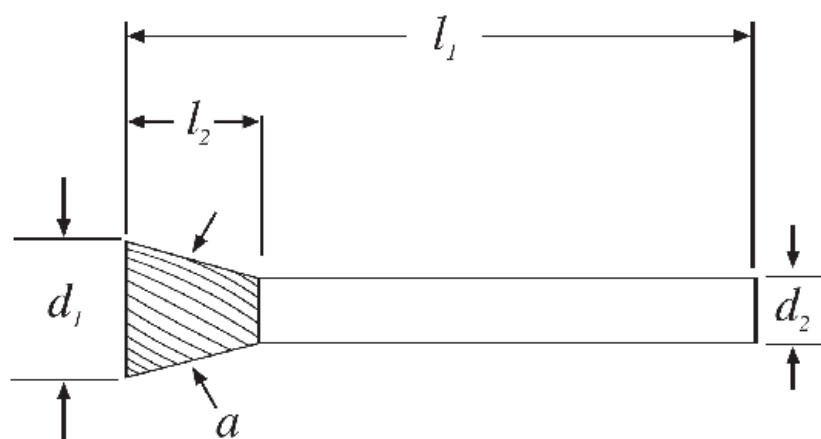

TURBÓMARÓK

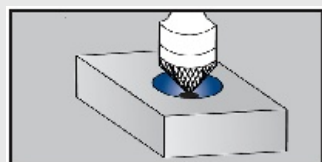
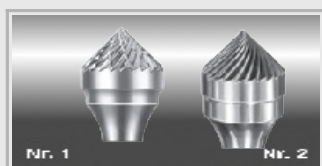
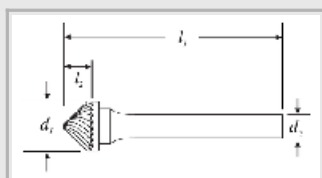
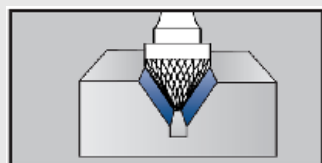
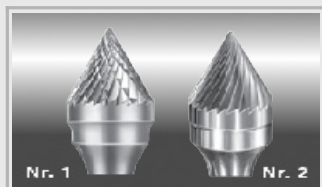
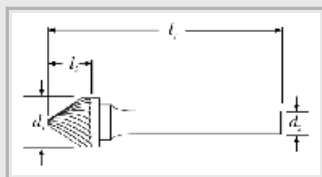

Turbómaró, kónuszos 60°, FJ forma

d_1 Fej Ø	l_2 Fejhossz.	l_1 Hossz.	d_2 Csap Ø	Nr. 1	Nr. 2
3	2,5	38	3	FJ – 3372	FJ – 3379

6	4	50	6	FJ – 3373	FJ – 3380
9,5	8	55	6	FJ – 3374	FJ – 3381
12,7	11	58	6	FJ – 3375	FJ – 3382
16	14,5	61	6	FJ – 3376	FJ – 3383
19	17,5	65	6	FJ – 3377	FJ – 3384
25	24,5	68	6	FJ – 3378	FJ – 3385

Turbómaró, kónuszos 90°, FK forma

d_1 Fej Ø	l_2 Fejhossz.	l_1 Hossz.	d_2 Csap Ø	Nr. 1	Nr. 2
3	1,5	38	3	FK – 3386	FK – 3393

6	3	50	6	FK – 3387	FK – 3394
9,5	4,7	52	6	FK – 3388	FK – 3395
12,7	6,3	54	6	FK – 3389	FK – 3396
16	8	57	6	FK – 3390	FK – 3397
19	9,5	58	6	FK – 3391	FK – 3398
25	12,7	60	6	FK – 3392	FK – 3399